



Salvi

Light inspired by you

Circus Lat



Circus Lat

Small, robust LED luminaire with optional brackets for various indoor and outdoor applications. An economical solution with superior light quality and significant energy savings.

Ideal for lighting pedestrian zones, residential areas, parks and gardens, parking lots, large areas, sports and industrial spaces.

Technical characteristics

Height

To be installed from 4 to 8 m

Dimensions

762 × Ø325 × 103 mm

Maximum power

Maximum power 134W

Peak flow

Maximum flux 17760lm.

Weight approx.

Approximate weight: 4.5 kg.

IP / IK

IP66 / IK08 / IK09

Colour temperature

3000°K or 4000°K. Optionally available for environmentally protected areas: amber filter, 2200°K or 2700°K.

FHS

< 0.1% (Cierre lenticular y vidrio plano)

CRI

Minimum 70

Lifespan

L90B10 > 100,000 h (consult according to LED type and configuration).

Voltage

AC 220 V - 240 V ~ 50/60 Hz
*Class I / Class II optional.

Color

Silver Grey G2. Other colors available.

Composition

Composed of body, top cover and fixing made of EN AC 44300 cast aluminium with low copper content (<0.1%).

Fixing

Lateral fixing to the post using a clamp and side arm in cast aluminum.

Closing/opening

Access to the equipment through the top cover, fixed to the body with M6 captive screws and a silicone gasket.

Diffuser

PMMA or tempered glass diffuser.

LED system

High-efficiency LED system in a circular arrangement. The type and number of LEDs vary depending on the version. There is a version

for every performance, durability, and cost requirement. SNAP optical group with ENEC certification.

Lenses

A set of independent lenses of our own design made of optical PMMA with a performance of up to 93%. Optionally, a rear flow-recovery reflector made of injected and aluminized PMMA with a high reflectivity index (95%). The wide range of lenses and reflectors available provides an optimal solution for all photometric needs.

Proportions

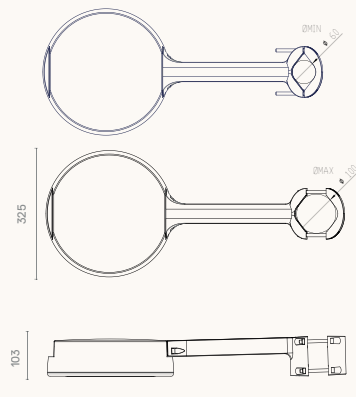

Standard

IEC 60598, IEC 62031, IEC 62471, IEC 60529, EN 55015, IEC 61000, IEC 61547, IEC 62493, IEC 62471, IEC 61437, IEC 62384, EN 50102, CE.

ISO

ISO 9001, ISO 14001, ISO 45001.

Photometries / Versions

Longitudinal Narrow F1M6

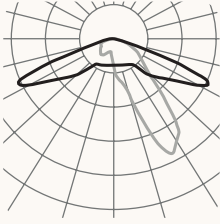

Longitudinal F2M2

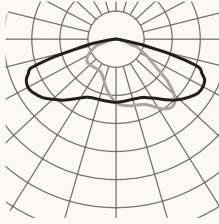

Longitudinal angle F3T3

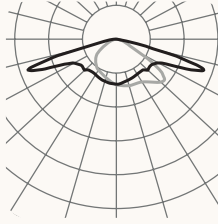

Longitudinal angle F3M3

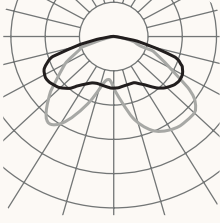

Frontal F4M2

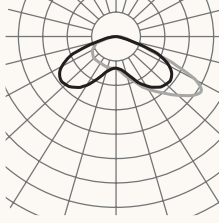

Extensive symmetry F5M1

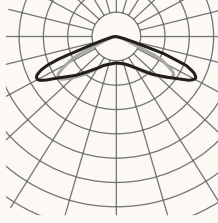

Please refer to the product configurator for other options.

Versions

PCB	mA	2700K			3000K	
		W	lm	lm/W	lm	lm/W
085	350	19	2720	143	2960	155
	500	26	3760	144	4080	156
	700	37	4960	134	5360	144
185	350	41	6120	149	6660	162
	500	59	8460	143	9180	155
	600	70	9720	138	10620	151
186	350	41	6120	149	6660	162
	500	59	8460	143	9180	155
	700	82	11160	136	12060	147
16U	350	17	2400	141	2560	150
	500	25	3360	134	3680	147
	700	34	4480	131	4960	145
16T	350	17	2400	141	2560	150
	500	25	3360	134	3680	147
	1400	68	8160	120	8960	131
16W	350	67	8640	128	9600	143
	500	96	12000	125	13280	138
	700	134	16000	119	17760	132
16Y	350	67	8640	128	9600	143
	500	96	12000	125	13280	138
	600	115	14080	122	15520	134
16C	350	18	2560	142	2720	151
	500	26	3520	135	3680	141
	1500	76	9120	120	9440	124
16D	350	18	2560	142	2720	151
	500	26	3520	135	3680	141
	700	36	4800	133	4960	137

Avda. del Vallés, 36 - 08185
Lliçà de Vall - Barcelona, Spain
www.salvi.es

Light inspired by you
info@salvi.es
+34 938 445 190

Salvi

2025-01 / Due to constant technological evolution, SALVI reserves the right to modify specifications without prior notice. The information contained in this document is for guidance only and does not constitute a contractual commitment.

